

Typ/Type 1

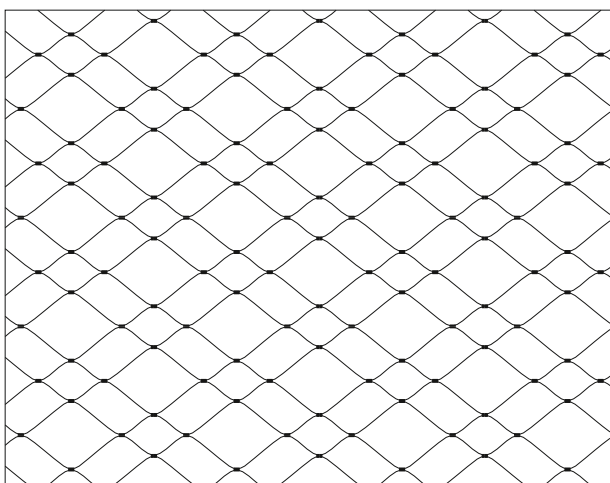

Typ/Type 2

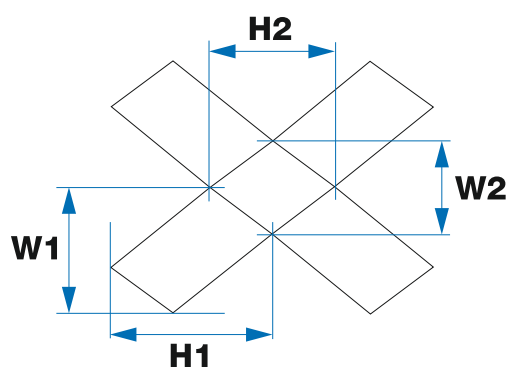
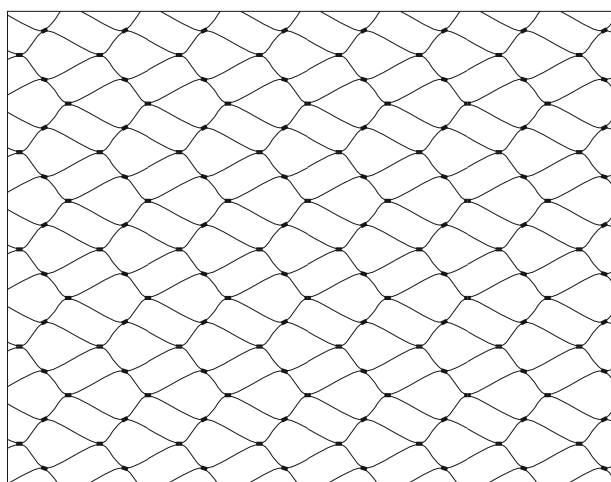
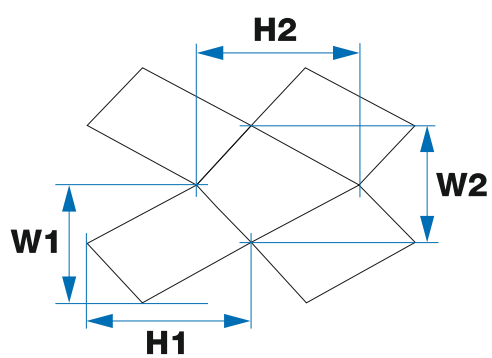

Typ/Type 3

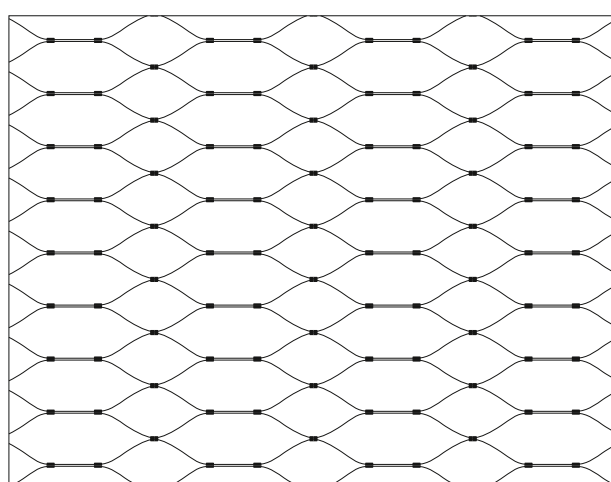
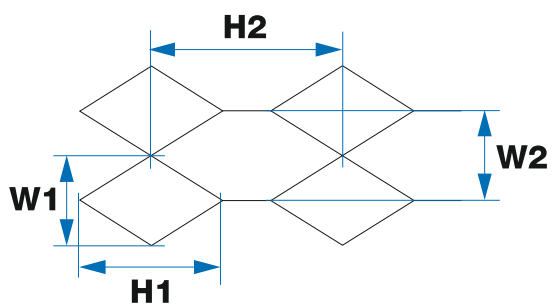

Typ/Type 4

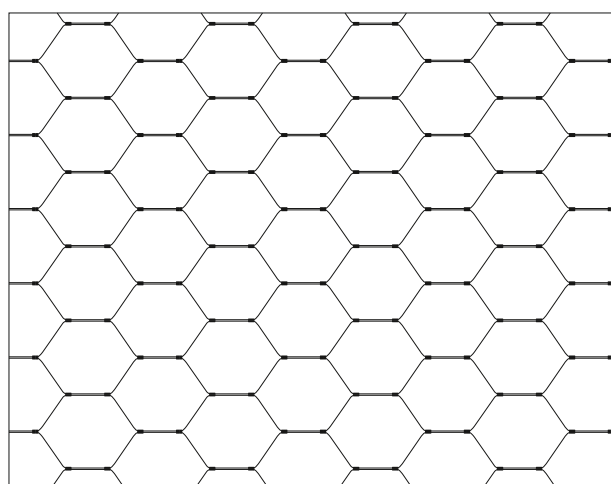
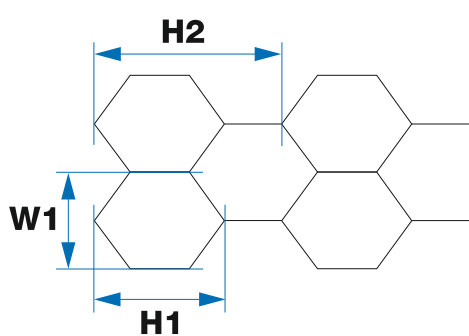

Typ/Type 5